

Ethernet analog output system

8 analog outputs (voltage and/or current), 16-bit



MSX-E3511 / MSX-E3511-C

8 analog outputs, 16-bit

Voltage or current outputs

Function generator for the output of any signal type, e. g. sine curves, sawtooth curves etc. – can be configured separately for each channel

M12 connector

24 V trigger input



Integrated Ethernet switch



*Operating temperature



ARM⁹ Technology

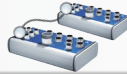

Cascadable, can be synchronised in the μ s range



on request



More information on www.addi-data.com

Features

- 24 V digital trigger input
- ARM⁹ 32-bit processor
- 64 MB onboard SDRAM for storing data
- Robust standardized metal housing
- Power Save Mode: Reduced power consumption when no acquisition runs

Safety features

- Status LEDs for fast error diagnostics
- Optical isolation
- Diagnostics in case of short-circuits (voltage mode) or line break (current mode)
- Internal temperature monitoring

Analog outputs

- 8 analog outputs, 16-bit:
MSX-E3511: voltage outputs 0-10 V, ± 10 V
MSX-E3511-C: each output can be configured as voltage or current output 0-20 mA
- Output voltage after reset 0 V
- 5-pin M12 female connector
- Output mode/operation mode: Data output per software function, trigger input or synchro output

Function generator

- Output of any signal type, e. g. sine curves, sawtooth curves etc.
- Maximal 8 channels (each channel independently)
- Can be used without programming skills, e. g. via .csv-file or mathematic functions such as $f(x) = \sin(x)$

Interfaces

- Fast 24 V trigger input
- Ethernet switch with 2 ports
- Synchronisation/trigger In/Out
- Line in for 24 V supply and cascading

Communication interfaces

- Web server (configuration and monitoring)
- Command server SOAP for transferring commands
- Data server (TCP/IP or UDP socket) for sending acquisition data
- Event server (TCP/IP socket) for sending system events (Diagnostics such as temperature, short-circuits ...)
- Command server Modbus TCP and Modbus (UDP) for sending commands

Synchronisation/time stamp

Time stamp

Several MSX-E systems can be synchronised with one another in the μ s range through a synchro connection. This allows to start a synchronous data acquisition, to generate trigger events and to synchronise the time on several MSX-E systems. Furthermore, the systems have a time stamp that logs the point in time at which the data was acquired by the system.

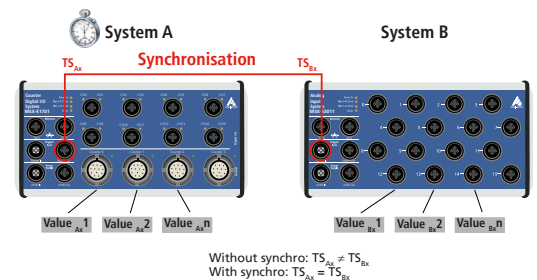

The combination of synchronisation and time stamp (TS) allows the clear allocation of signals that were captured by several systems.

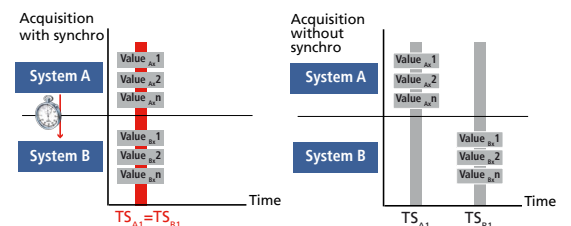



Output modes

Output modes – Analog output values can be generated either via direct access or through function generator:

1. Direct access

In direct access, the values of the outputs are transmitted via SOAP or Modbus function.

For each function call, 1 value (for one or several outputs) is sent.

The value output is triggered per software, 24V hardware or synchro trigger.

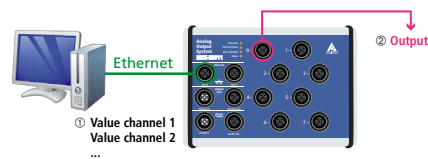

2. Function generator

The MSX-E3511 system features a function generator for each analog output. The values are sent either automatically at a defined rate or using a trigger. The 24V trigger input or the synchro trigger can be used, included those issued by another MSX-E system.

Generator with CSV file

The value are transmitted to the function generator via a CSV file which contains both the values and the number of cycles for each value.

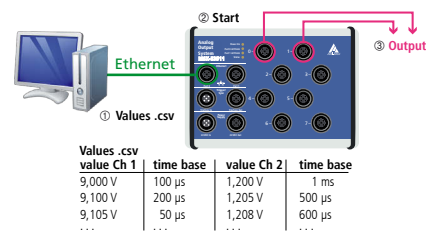

Generator with mathematical formula

The values are generated through a formula, e.g. $f(x) = \sin(x)$.

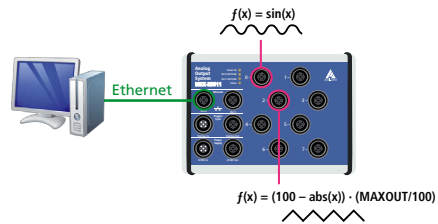

„Single Mode“ Generator

In „Single Mode“, an array with values is sent to the respective generator via SOAP function. After all values have been transmitted, the generator stops automatically (outputs = 0V).

„Continuous Mode“ Generator

In „Continuous Mode“, an array with values is sent to the respective generator via SOAP function. After all values have been transmitted, the generator automatically starts again at the first value.

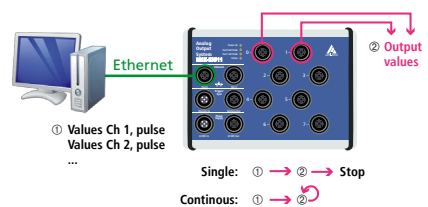

Onboard programming / stand-alone operation

Development mode

With the Development mode of the MSX-E systems you can customise your measurement, control and regulation applications to fit your requirements. The programs run directly on the MSX-E systems, which has two advantages: external PCs are relieved and you can process data freely according to your requirements. This helps you to improve the efficiency of your processes and to secure your investments.

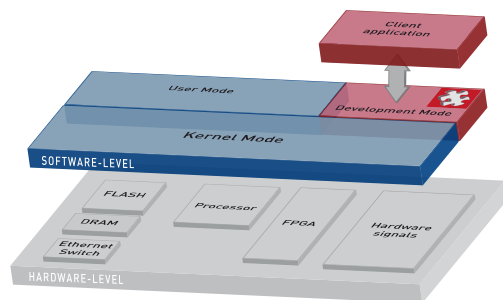

Safety

Watchdog

The MSX-E3511 Ethernet system has a 16-bit watchdog which can be programmed in 3 time units (µs, ms, s). The watchdog is used for automatically resetting the digital outputs to 0 V after a defined time in order e. g. to switch off actuators if an error has occurred.

ConfigTools

The **ConfigTools** program allows an easy administration of the MSX-E systems. These are automatically detected in the network. **ConfigTools** consists of common and specific functions. In addition, with **ConfigTools**, the complete configuration of a MSX-E system can be saved and transferred to another system of the same type (clone function).

ConfigTools is included in the delivery.

ConfigTools functions for MSX-E3511 / MSX-E3511-C:

- Change of IP address
- Display of web interface
- Firmware update
- Save/load system configuration

Very easy use through the „ConfigTools“ program; The MSX-E system is automatically detected in the network.

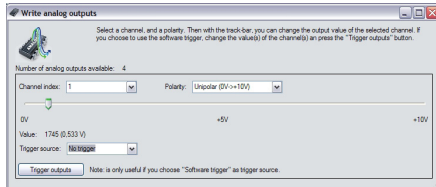
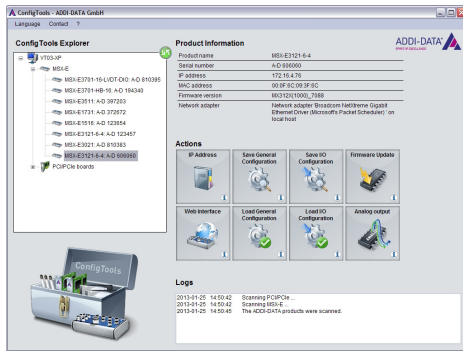

Example of monitor function:
Testing the analog outputs – Value output without programming.

Features

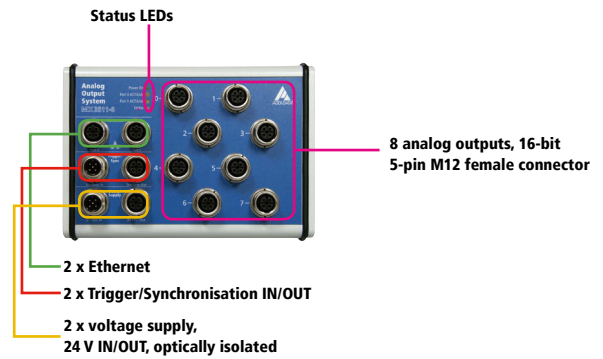

Simplified block diagram

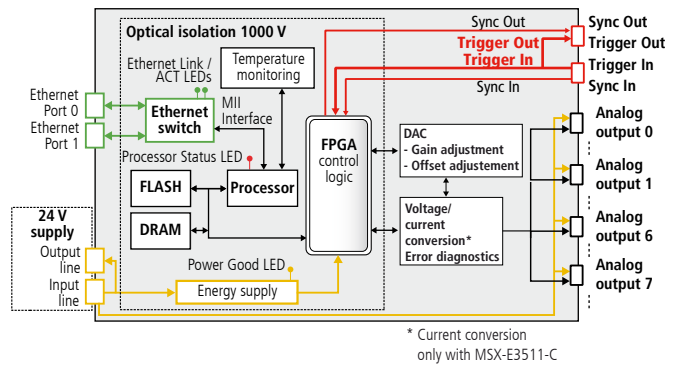

Cascading

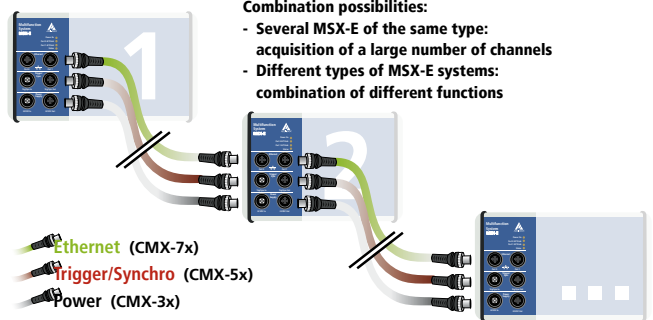

- Combination possibilities:**
- Several MSX-E of the same type: acquisition of a large number of channels
 - Different types of MSX-E systems: combination of different functions

ADDI-DATA connection technology

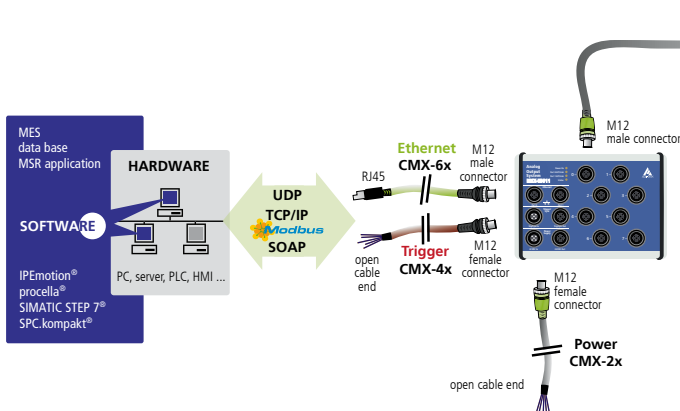

5V digital	24V digital	B ₁ C NPN E 24 V dig. input	A ₁ B Incremental
PWM	A Sin B Cos 1 V _{pp}	A Sin B Cos 11 μA _{pp}	IBIS
EnDat2.2	SSI	I current	ICP sensor
U voltage	NTC temperature	Pt100	thermocouple element
DMS	HB inductive transducer	LVDT inductive transducer	VLDT inductive transducer
RS232 serial	RS422 serial	RS485 serial	TTY serial



Specifications

Analog outputs

Number of outputs:	8	
Resolution:	16-bit (bipolar) 15-bit (unipolar)	
Optical isolation:	1000 V	
Output range:	voltage output:	0-10 V (± 10 V)
	current output:	0-20 mA
Output velocity:	Voltage version: max. 40 kHz Voltage version: max. 25 kHz FSR (Full Scale Range) Current version: depending on load	
Overvoltage protection:	± 14 V	
Output current/Last:	voltage output:	15 mA, min. 680 Ω
	current output:	20 mA, max. 550 Ω
Short-circuit current:	Voltage output:	± 20 mA
	Current output:	± 32 mA
Output value after reset	0 V voltage output, not calibrated	
↑ watchdog (programmable):	16-bit, 1 μ s to 65535 s	

Voltage supply, Ethernet, Trigger, Synchro

The specifications for the voltage supply, Ethernet, Trigger, Synchronisation and Electromagnetic Compatibility apply to all MSX-E systems. See page 31.

System features

Interface:	Ethernet acc. to specification IEEE802.3	
Dimensions:	154 mm x 110 mm x 50 mm	
Weight:	620 g	
Degree of protection:	IP 65	
Current consumption at 24 V:	150 mA	without load
	310 mA	current outputs switched on
	410 mA	voltage outputs switched on
Operating temperature:	- 40°C to + 85°C	

Connectors for sensors

Analog outputs 8 x 5-pin M12 female connector

Ordering information

MSX-E3511 / MSX-E3511-C

Ethernet analog output system, 8 analog outputs (voltage and/or current), 16-bit. Incl. technical description, software drivers and ConfigTools.

Versions

MSX-E3511-C: Ethernet analog output system, 8 analog outputs (voltage and/or current), 16-bit

MSX-E3511: Ethernet analog output system, 8 analog outputs, only voltage for fast signal output, 16-bit

Connection cables

Voltage supply

CMX-2x: Shielded cable, M12 5-pin female connector/open end, IP 65

CMX-3x: For cascading, shielded cable, M12 5-pin female connector/male connector IP 65

Trigger/Synchro

CMX-4x: Shielded cable, M12 5-pin female connector/open end, IP 65

CMX-5x: For cascading, shielded cable, M12 5-pin female connector/male connector IP 65

Ethernet

CMX-6x: CAT5E cable, M12 D-coded male connector/RJ45 connector

CMX-7x: For cascading, CAT5E cable, 2 x M12 D-coded male connector

Connection to peripherals

CMX-8x: Shielded cable, M12 5-pin male connector/open end, IP 65

Options

S7 Modbus TCP Client Library for S7: Easy use of the Ethernet systems MSX-E with PLCs

MSX-E 5V-Trigger: Level change of the trigger inputs and outputs to 5 V

MX-Clip, MX-Rail (please specify when ordering!),

MX-Screw, PCMX-1x